

ay



oy



ie

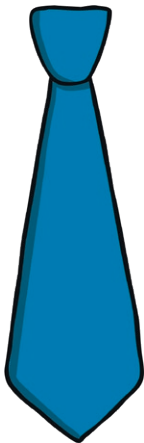

ea

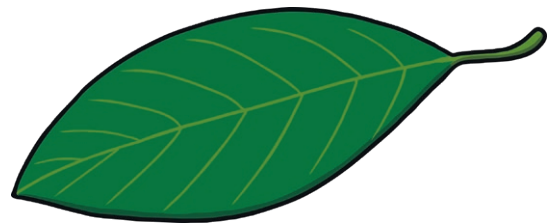

a_e



i_e



o_e



u_e



u_e

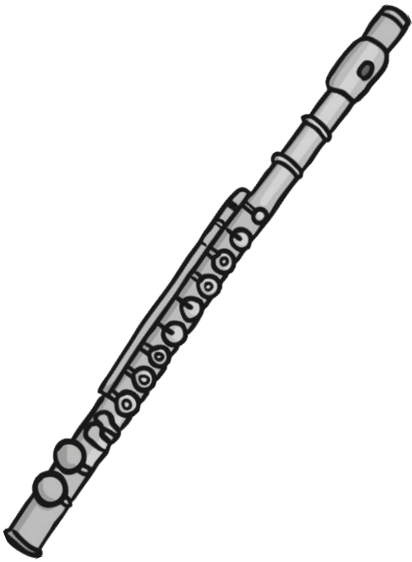

e_e



ou

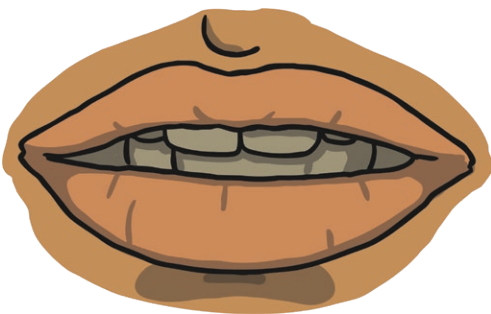

a

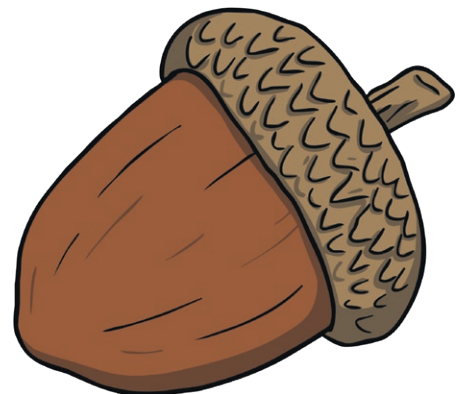

e

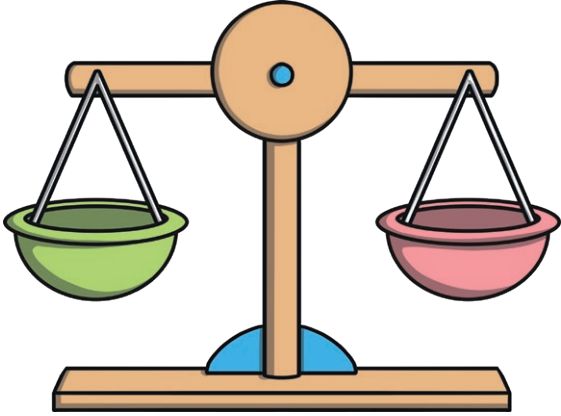

i

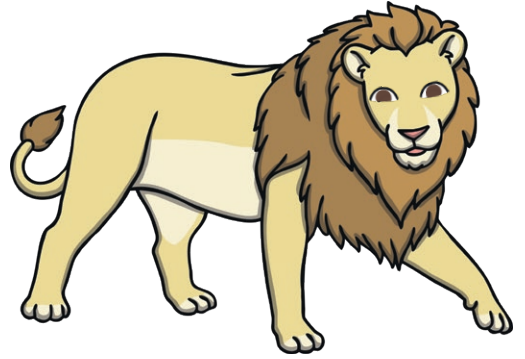

o



u



ch



ch



ir



ue



ue



ew

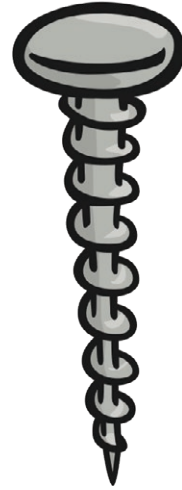

ew

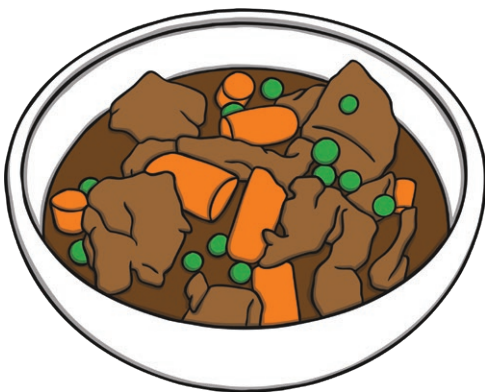

y

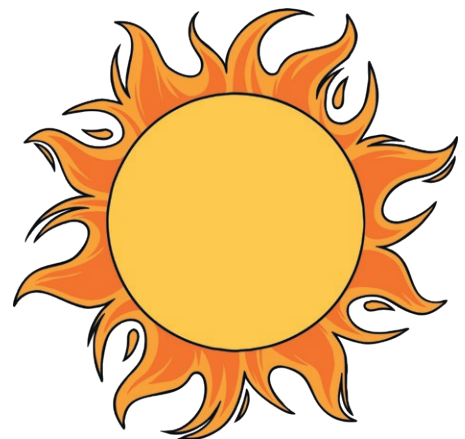

aw

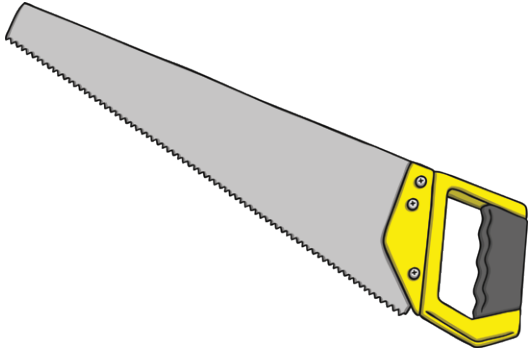

au



ow



oe

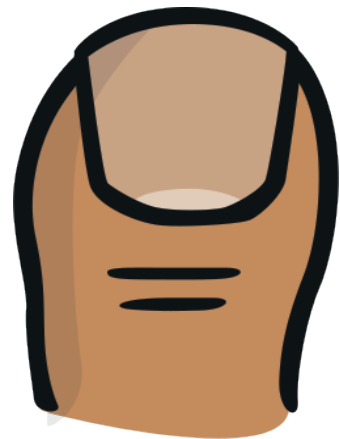

wh

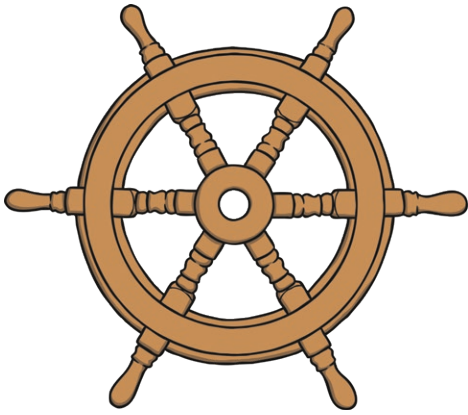

c



g

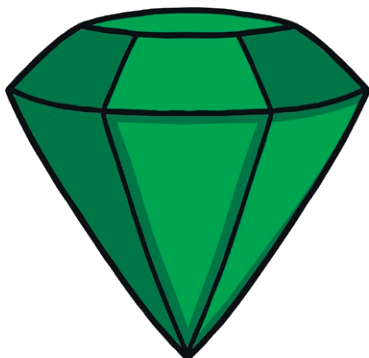

ph

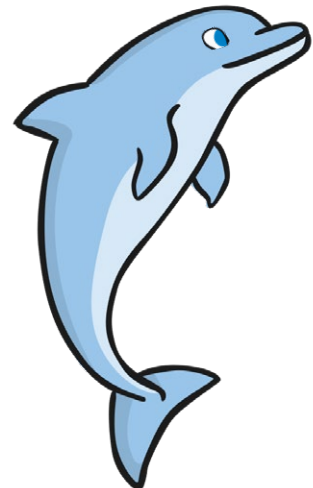

ea

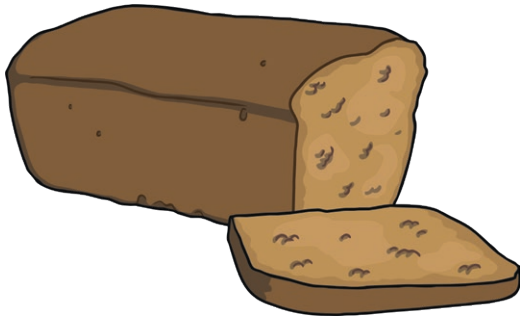

ie



tch



are

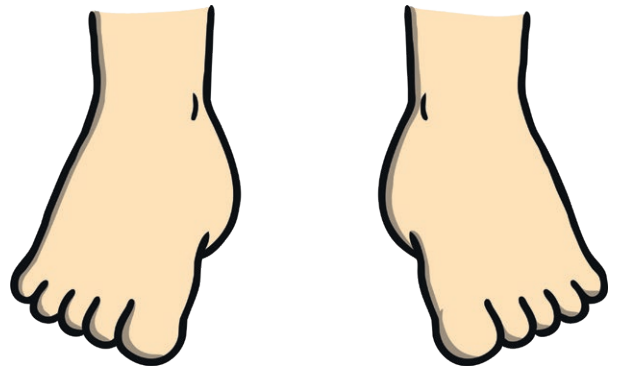

ear

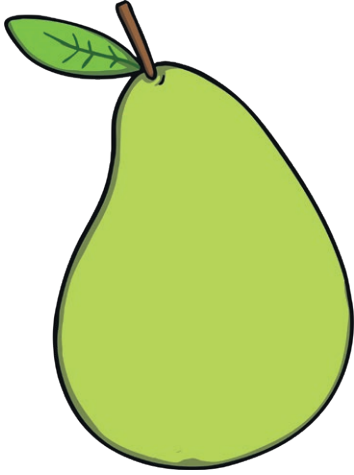

ore

